

ROC-BASE

Granite • Quartz • Shower Bases

877-652-2514 | support@roc-base.com | roc-base.com



Centro

Granite or quartz shower pan
Central drain

40/50-6032

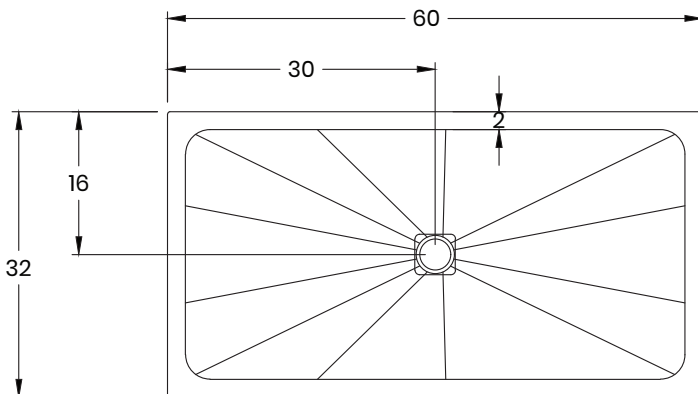

Dimensions

Length :	60" (1524mm)
Width :	32" (813mm)
Thickness :	1 1/4" (30mm) (1mm to 3mm tolerance)
Weight :	200 LBS (90 KG)

Material

Base : Quartz or granite core

Drain cover : Stainless steel (with optional black finish)

Texture : Non-slip

Colors

Stock :



40-6032-07
Cambrian black



50-6032-HCL119
Tofino



50-6032-HRU609
Uptown Grey

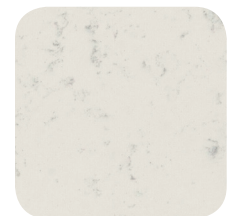

50-6032-HBA252
Whistler

* Other colors may be available upon request

Included

- Stainless steel drain (black finish optional)
- Tile flange
- Installation instructions

Features

- CSA B45.8/IAPMO Z403
- Non-slip surface
- Made from durable granite or quartz
- Easy maintenance and cleaning
- Customizable